

Genie® GS™ -1432m & GS-1932m

Specifications

Models	GS-1432m E-Drive		GS-1932m E-Drive	
Measurements	US	Metric	US	Metric
Working height max. - indoor ⁽¹⁾	20 ft 1 in	6.30 m	24 ft 2 in	7.55 m
Working height max. - outdoor ⁽¹⁾	18 ft	5.66 m	21 ft	6.57 m
A Platform height max. - indoor	14 ft 1 in	4.30 m	18 ft 2 in	5.55 m
A Platform height max. - outdoor	12 ft	3.66 m	15 ft	4.57 m
B Platform height - stowed	2 ft 6 in	0.77 m	2 ft 10 in	0.87 m
C Platform length - outside	4 ft 7 in	1.40 m	4 ft 7 in	1.40 m
C Platform length - outside, extended	6 ft 7 in	2.00 m	6 ft 7 in	2.00 m
Slide-out platform extension deck - length	2 ft	0.60 m	2 ft	0.60 m
D Platform width - outside	2 ft 6 in	0.77 m	2 ft 6 in	0.77 m
Guardrail height	3 ft 7 in	1.10 m	3 ft 7 in	1.10 m
Toeboard height	6 in	15 cm	6 in	15 cm
E Height - stowed (fixed rails)	6 ft 2 in	1.88 m	6 ft 5 in	1.97 m
E Height - stowed (folding rails)	6 ft 2 in	1.88 m	6 ft 5 in	1.97 m
E Height - stowed (rails lowered)	4 ft 11 in	1.49 m	5 ft 2 in	1.58 m
F Length machine - stowed	4 ft 7 in	1.40 m	4 ft 7 in	1.40 m
F Length machine - stowed, extended	6 ft 7 in	2.00 m	6 ft 7 in	2.00 m
G Width	32 in	0.81 m	32 in	0.81 m
H Wheelbase	3 ft 8 in	1.12 m	3 ft 8 in	1.12 m
I Ground clearance (center) - pothole guards retracted	2.8 in	7 cm	2.8 in	7 cm
I Ground clearance - pothole guards deployed	0.75 in	2 cm	0.75 in	2 cm

Productivity

Maximum platform occupancy (in/out)	2/1	2/1	2/1	2/1
Lift capacity	500 lb	227 kg	500 lb	227 kg
Lift capacity - extension deck extended	250 lb	113 kg	250 lb	113 kg
Max. platform drive height	14 ft 1 in	4.30 m	18 ft 2 in	5.55 m
Drive speed - stowed	2.5 mph	4.0 km/h	2.5 mph	4.0 km/h
Drive speed - raised	0.5 mph	0.8 km/h	0.5 mph	0.8 km/h
Gradeability - stowed ⁽²⁾	25%/14°	25%/14°	25%/14°	25%/14°
Turning radius - inside/outside	0/4 ft 6 in	0/1.37 m	0/4 ft 6 in	0/1.37 m
Lifting speed - raise/lower	19/20 sec	19/20 sec	26/20 sec	26/20 sec
Tilt sensor activation (front to back/side to side)	3°/1.5°	3°/1.5°	3°/1.5°	3°/1.5°
Tires - solid non-marking	10×3 in	25.4×7.62 cm	10×3 in	25.4×7.62 cm

Power

Power	24 V DC (2×12 V 150 Ah)	24 V DC (2×12 V 150 Ah)	24 V DC (2×12 V 150 Ah)	24 V DC (2×12 V 150 Ah)
Hydraulic tank capacity (E-Drive)	1 gal	3.8 L	1 gal	3.8 L

Weight⁽³⁾ and Floor Loading⁽⁴⁾

Weight	1,984 lb	900 kg	2,600 lb	1,179 kg
Tire load max.	425 lb	193 kg	570 lb	259 kg
Tire contact pressure	143 psi	988 kPa	164 psi	1,131 kPa
Occupied floor pressure	203 psf	9.73 kPa	254 psf	12.16 kPa

Sound and Vibration Levels

Sound Pressure level (ground workstation)	< 70 dBA	< 70 dBA	< 70 dBA	< 70 dBA
Sound Pressure level (platform workstation)	< 70 dBA	< 70 dBA	< 70 dBA	< 70 dBA
Vibrations	< 2.5 m/s ²	< 2.5 m/s ²	< 2.5 m/s ²	< 2.5 m/s ²

(1) The metric equivalent of working height adds 2 m to platform height. US adds 6 ft to platform height.

(2) Gradeability applies to driving on slopes and may vary depending on options and machine configurations. See operator's manual for details regarding slope ratings.

(3) Weight refers to standard configuration and may vary depending on options and/or country standards.

(4) Floor loading information is approximate and may vary depending on options and machine configurations. It should be used only with adequate safety factors.

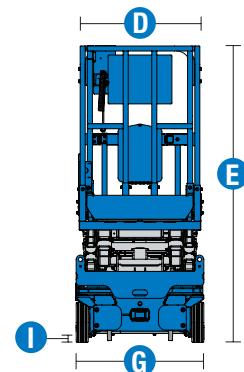
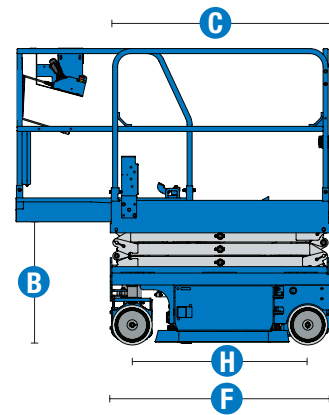
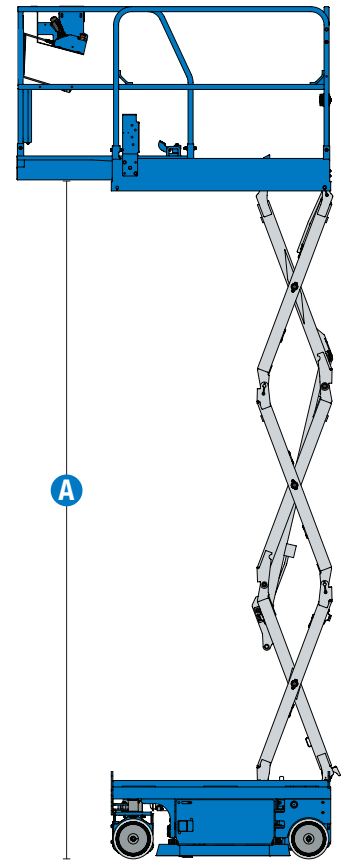

Genie® GS™ -1432m & GS-1932m

Models

- GS-1432m, E-Drive

Models

- GS-1932m, E-Drive

Option availability		S	S+	BtO
Power	AGM Maintenance-free batteries			○
	Rear recessed charger receptacle	✓	✓	✓
Platform	Fixed rails, Half-height swing gate	✓	✓	✓
	Folding rails, Half-height swing gate			○
	Power to platform with RCBO		○	○
	Power to platform, no RCBO	✓	✓	✓
	Air line to platform			○
	Automotive-style horn		○	○
	Lift Tools Work Tray		○	○
	AC power to platform	✓	✓	✓
	Descent, tilt and motion alarm	✓	✓	✓
	Diamond plate platform	✓	✓	✓
	Dual LED flashing beacons	✓	✓	✓
	Electric horn	✓	✓	✓
	Lanyard attachment points	✓	✓	✓
	Platform control guard	✓	✓	✓
	Platform load sense system	✓	✓	✓
	Proportional drive and lift	✓	✓	✓
	Slide out extension deck	✓	✓	✓
SmartLink dual zone control system	✓	✓	✓	
Chassis	Lift Connect Telematics		○	○
	Lift Connect with Access Manager upgrade		○	○
	Eco32 biodegradable hydraulic oil		○	○
	Auxiliary platform lowering	✓	✓	✓
	Dual front wheel AC electric drive motors	✓	✓	✓
	Dual front wheel electric brakes	✓	✓	✓
	Electric brake release	✓	✓	✓
	Fork pockets	✓	✓	✓
	On board diagnostic system with battery indicator	✓	✓	✓
	Pothole protection	✓	✓	✓
Solid non-marking tires	✓	✓	✓	
Tech Pro Link connector	✓	✓	✓	
Tie-down and lifting points	✓	✓	✓	

- S Standard
- S+ Standard +
- BtO Build to Order
- Options



Compact Footprint



Lightweight



E-Drive



Genie Genuine Accessories⁽¹⁾

- Lift Tools Productivity Tools
- Lift Connect Telematics
- Tech Pro Link Handheld Device

(1) More accessories available from Genie Genuine Parts.

Product specifications are subject to change without notice or obligation. Photographs and/or drawings herein are for illustrative purposes only. Refer to the appropriate Operator's Manual for instructions on proper equipment use. Failure to follow instructions in the Operator's Manual may result in serious injury or death. The only warranty applicable to our equipment is the standard written warranty applicable to the particular product and sale and we make no other warranty, express or implied. Products and services listed may be trademarks, service marks or trade names of Terex Corporation and/or their subsidiaries in the USA and many other countries. Terex, Genie, Quality By Design, Xtra Capacity, Lift Power, Lift Guard, Lift Tools, Lift Connect and Tech Pro Link are registered trademarks of Terex Corporation or its subsidiaries.

Updated 08/21

GEN2601